

# GRILLO - Laufhilfe Large

Rechnungsanschrift	
Firma	
Straße und Nr.	
PLZ & Ort	
Telefon	
E-Mail	
<b>Angebot</b>	<b>Bestellung</b>
<input type="checkbox"/>	<input type="checkbox"/>
Lieferadresse	
Firma	
Straße und Nr.	
PLZ & Ort	
Telefon	
E-Mail	
Kommission	
Name	
Nummer	
Besteller	Datum



Anterior  
vorwärts

Posterior  
rückwärts















Abb. Enthält Zubehör





**Grundausstattung:**









- ✓ Beckenstütze
- ✓ Ergonomische Sitzhose
- ✓ schwenkräder mit Richtungsfeststeller
- ✓ Hinterräder mit Bremse, Rücklaufstopp, Schleifbremse



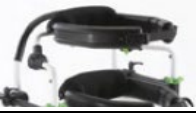

**HMV Nummer 10.46.02.3047**

 <p>84 - 147 63 - 120</p> <p>111      80</p>	 <p>63 - 120</p> <p>111      80</p>
<p>Anterior max. Belastung 110kg Körpergröße 150 - 190cm</p>	<p>Posterior max. Belastung 110kg Körpergröße 150 - 190cm</p>

	VERSION PT	VERSION PA	VERSION P
<b>Grillo Large</b>  <b>Variante Posterior (rückwärts)</b>			
	Inklusive: - Thoraxstütze - Beckenstütze - Sitzhose - Handgriffe	Inklusive: - Beckenstütze - Sitzhose - Unterarmauflage	Inklusive: - Beckenstütze - Sitzhose - Handgriffe
Preis Grundmodell	840100105074 <input type="checkbox"/> 4.965 €	840100105080 <input type="checkbox"/> 4.788 €	840100105086 <input type="checkbox"/> 4.092 €
<b>Zubehör Thoraxstütze (925)</b>			
	Inklusive	840100105116 <input type="checkbox"/> 982 €	840100105116 <input type="checkbox"/> 982 €
<b>Zubehör Einstellbare Kopfstütze (865) nur in Verbindung mit Thoraxstütze</b>			
	840100105178 <input type="checkbox"/> 480 €	840100105178 <input type="checkbox"/> 480 €	840100105178 <input type="checkbox"/> 480 €
<b>Zubehör Ergonomischer Sattel (946)</b>			
	840100105184 <input type="checkbox"/> 308 €	840100105184 <input type="checkbox"/> 308 €	840100105184 <input type="checkbox"/> 308 €
<b>Zubehör untere Schrittführung (890-SC)</b>			
	840100105108 <input type="checkbox"/> 622 €	840100105108 <input type="checkbox"/> 622 €	840100105108 <input type="checkbox"/> 622 €
<b>Zubehör Beintrennschiene mit Beinführung (890-C)</b>			
	840100105098 <input type="checkbox"/> 685 €	840100105098 <input type="checkbox"/> 685 €	840100105098 <input type="checkbox"/> 685 €
<b>Zubehör Unterarmauflage (809)</b>			
	840100105146 <input type="checkbox"/> 751 €	Inklusive	840100105146 <input type="checkbox"/> 751 €
<b>Zubehör Armschlaufen für Unterarmauflage (943)</b>			
	840100105150 <input type="checkbox"/> 42 €	840100105150 <input type="checkbox"/> 42 €	840100105150 <input type="checkbox"/> 42 €
	VERSION PT	VERSION PA	VERSION P

	VERSION PT	VERSION PA	VERSION P
<b>Zubehör Ergonomische Handgriffe (939)</b>			
	840100105136	840100105136	840100105136
	<input type="checkbox"/>	<input type="checkbox"/>	<input type="checkbox"/>
	162 €	162 €	162 €
<b>Zubehör abklappbare Abduktionsführung(815)</b>			
	840100105176	840100105176	840100105176
	<input type="checkbox"/>	<input type="checkbox"/>	<input type="checkbox"/>
	390 €	390 €	390 €
<b>Zubehör Zusatzgewichte Rahmen (810)</b>			
	840100105166	840100105166	840100105166
	<input type="checkbox"/>	<input type="checkbox"/>	<input type="checkbox"/>
	194 €	194 €	194 €
<b>Hinterräder nach innen Versetzt <span style="color: red;">nur für Innenräume</span> (928)</b>			
	840100105168	840100105168	840100105168
	<input type="checkbox"/>	<input type="checkbox"/>	<input type="checkbox"/>
	195 €	195 €	195 €
	VERSION PT	VERSION PA	VERSION P

	VERSION PT	VERSION PA	VERSION P
<b>Grillo Large</b>  <b>Variante Anterior (vorwärts)</b>			
	Inklusive: - Thoraxstütze - Beckenstütze - Sitzhose - Handbügel	Inklusive: - Beckenstütze - Sitzhose - Unterarmauflage	Inklusive: - Beckenstütze - Sitzhose - Handbügel
Preis Grundmodell	840100105056 <input type="checkbox"/> 4.965 €	840100105062 <input type="checkbox"/> 4.788 €	840100105068 <input type="checkbox"/> 4.092 €
<b>Zubehör Thoraxstütze (925)</b>			
	Inklusive	840100105116 <input type="checkbox"/> 982 €	840100105116 <input type="checkbox"/> 982 €
<b>Zubehör Ergonomischer Sattel (946)</b>			
	840100105184 <input type="checkbox"/> 308 €	840100105184 <input type="checkbox"/> 308 €	840100105184 <input type="checkbox"/> 308 €
<b>Zubehör untere Schrittführung (890-SC)</b>			
	840100105108 <input type="checkbox"/> 622 €	840100105108 <input type="checkbox"/> 622 €	840100105108 <input type="checkbox"/> 622 €
<b>Zubehör Beintrennschiene mit Beinführung (890-C)</b>			
	840100105098 <input type="checkbox"/> 685 €	840100105098 <input type="checkbox"/> 685 €	840100105098 <input type="checkbox"/> 685 €
<b>Zubehör Unterarmauflage (809)</b>			
	840100105146 <input type="checkbox"/> 751 €	Inklusive	840100105146 <input type="checkbox"/> 751 €
<b>Zubehör Armschlaufen für Unterarmauflage (943)</b>			
	840100105150 <input type="checkbox"/> 42 €	840100105150 <input type="checkbox"/> 42 €	840100105150 <input type="checkbox"/> 42 €
	VERSION PT	VERSION PA	VERSION P

	VERSION PT	VERSION PA	VERSION P
<b>Zubehör Ergonomische Handgriffe (939)</b>			
	840100105138 <input type="checkbox"/> 128 €	840100105138 <input type="checkbox"/> 128 €	840100105138 <input type="checkbox"/> 128 €
<b>Zubehör abklappbare Abduktionsführung(815)</b>			
	840100105176 <input type="checkbox"/> 390 €	840100105176 <input type="checkbox"/> 390 €	840100105176 <input type="checkbox"/> 390 €
<b>Zubehör Zusatzgewichte Rahmen (810)</b>			
	840100105166 <input type="checkbox"/> 194 €	840100105166 <input type="checkbox"/> 194 €	840100105166 <input type="checkbox"/> 194 €
<b>Hinterräder nach innen Versetzt <span style="color: red;">nur für Innenräume</span> (928)</b>			
	840100105168 <input type="checkbox"/> 195 €	840100105168 <input type="checkbox"/> 195 €	840100105168 <input type="checkbox"/> 195 €
	VERSION PT	VERSION PA	VERSION P