

GRILLO - Laufhilfe Large

Rechnungsanschrift	
Firma	
Straße und Nr.	
PLZ & Ort	
Telefon	
E-Mail	
Angebot	Bestellung
<input type="checkbox"/>	<input type="checkbox"/>
Lieferadresse	
Firma	
Straße und Nr.	
PLZ & Ort	
Telefon	
E-Mail	
Kommission	
Name	
Nummer	
Besteller	Datum



Anterior
vorwärts

Posterior
rückwärts















Abb. Enthält Zubehör





Grundausrüstung:









- ✓ Beckenstütze
- ✓ Ergonomische Sitzhose
- ✓ schwenkräder mit Richtungsfeststeller
- ✓ Hinterräder mit Bremse, Rücklaufstopp, Schleifbremse



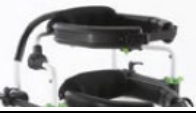

HMV Nummer 10.46.02.3047

	
<p>Anterior max. Belastung 110kg Körpergröße 150 - 190cm</p>	<p>Posterior max. Belastung 110kg Körpergröße 150 - 190cm</p>

	VERSION PT	VERSION PA	VERSION P
Grillo Large Variante Posterior (rückwärts)			
	Inklusive: - Thoraxstütze - Beckenstütze - Sitzhose - Handgriffe	Inklusive: - Beckenstütze - Sitzhose - Unterarmauflage	Inklusive: - Beckenstütze - Sitzhose - Handgriffe
Preis Grundmodell	840100105074 <input type="checkbox"/> 5.395 €	840100105080 <input type="checkbox"/> 5.203 €	840100105086 <input type="checkbox"/> 4.447 €
Zubehör Thoraxstütze (925)			
	Inklusive	840100105116 <input type="checkbox"/> 1.036 €	840100105116 <input type="checkbox"/> 1.036 €
Zubehör Einstellbare Kopfstütze (865) nur in Verbindung mit Thoraxstütze			
	840100105178 <input type="checkbox"/> 521 €	840100105178 <input type="checkbox"/> 521 €	840100105178 <input type="checkbox"/> 521 €
Zubehör Ergonomischer Sattel (946)			
	840100105184 <input type="checkbox"/> 335 €	840100105184 <input type="checkbox"/> 335 €	840100105184 <input type="checkbox"/> 335 €
Zubehör untere Schrittführung (890-SC)			
	840100105108 <input type="checkbox"/> 676 €	840100105108 <input type="checkbox"/> 676 €	840100105108 <input type="checkbox"/> 676 €
Zubehör Beintrennschiene mit Beinführung (890-C)			
	840100105098 <input type="checkbox"/> 745 €	840100105098 <input type="checkbox"/> 745 €	840100105098 <input type="checkbox"/> 745 €
Zubehör Unterarmauflage (809)			
	840100105146 <input type="checkbox"/> 816 €	Inklusive	840100105146 <input type="checkbox"/> 816 €
Zubehör Armschlaufen für Unterarmauflage (943)			
	840100105150 <input type="checkbox"/> 45 €	840100105150 <input type="checkbox"/> 45 €	840100105150 <input type="checkbox"/> 45 €
	VERSION PT	VERSION PA	VERSION P

	VERSION PT	VERSION PA	VERSION P
Zubehör Ergonomische Handgriffe (939)			
	840100105136 <input type="checkbox"/> 176 €	840100105136 <input type="checkbox"/> 176 €	840100105136 <input type="checkbox"/> 176 €
Zubehör abklappbare Abduktionsführung(815)			
	840100105176 <input type="checkbox"/> 423 €	840100105176 <input type="checkbox"/> 423 €	840100105176 <input type="checkbox"/> 423 €
Zubehör Zusatzgewichte Rahmen (810)			
	840100105166 <input type="checkbox"/> 211 €	840100105166 <input type="checkbox"/> 211 €	840100105166 <input type="checkbox"/> 211 €
Hinterräder nach innen Versetzt nur für Innenräume (928)			
	840100105168 <input type="checkbox"/> 212 €	840100105168 <input type="checkbox"/> 212 €	840100105168 <input type="checkbox"/> 212 €
	VERSION PT	VERSION PA	VERSION P

	VERSION PT	VERSION PA	VERSION P
Grillo Large Variante Anterior (vorwärts)			
	Inklusive: - Thoraxstütze - Beckenstütze - Sitzhose - Handbügel	Inklusive: - Beckenstütze - Sitzhose - Unterarmauflage	Inklusive: - Beckenstütze - Sitzhose - Handbügel
Preis Grundmodell	840100105056 <input type="checkbox"/> 5.395 €	840100105062 <input type="checkbox"/> 5.203 €	840100105068 <input type="checkbox"/> 4.447 €
Zubehör Thoraxstütze (925)			
	Inklusive	840100105116 <input type="checkbox"/> 1.067 €	840100105116 <input type="checkbox"/> 1.067 €
Zubehör Ergonomischer Sattel (946)			
	840100105184 <input type="checkbox"/> 335 €	840100105184 <input type="checkbox"/> 335 €	840100105184 <input type="checkbox"/> 335 €
Zubehör untere Schrittführung (890-SC)			
	840100105108 <input type="checkbox"/> 676 €	840100105108 <input type="checkbox"/> 676 €	840100105108 <input type="checkbox"/> 676 €
Zubehör Beintrennschiene mit Beinführung (890-C)			
	840100105098 <input type="checkbox"/> 745 €	840100105098 <input type="checkbox"/> 745 €	840100105098 <input type="checkbox"/> 745 €
Zubehör Unterarmauflage (809)			
	840100105142 <input type="checkbox"/> 780 €	Inklusive	840100105142 <input type="checkbox"/> 780 €
Zubehör Armschlaufen für Unterarmauflage (943)			
	840100105150 <input type="checkbox"/> 45 €	840100105150 <input type="checkbox"/> 45 €	840100105150 <input type="checkbox"/> 45 €
	VERSION PT	VERSION PA	VERSION P

	VERSION PT	VERSION PA	VERSION P
Zubehör Ergonomische Handgriffe (939)			
	840100105138 <input type="checkbox"/> 139 €	840100105138 <input type="checkbox"/> 139 €	840100105138 <input type="checkbox"/> 139 €
Zubehör abklappbare Abduktionsführung(815)			
	840100105176 <input type="checkbox"/> 423 €	840100105176 <input type="checkbox"/> 423 €	840100105176 <input type="checkbox"/> 423 €
Zubehör Zusatzgewichte Rahmen (810)			
	840100105166 <input type="checkbox"/> 211 €	840100105166 <input type="checkbox"/> 211 €	840100105166 <input type="checkbox"/> 211 €
Hinterräder nach innen Versetzt nur für Innenräume (928)			
	840100105168 <input type="checkbox"/> 212 €	840100105168 <input type="checkbox"/> 212 €	840100105168 <input type="checkbox"/> 212 €
	VERSION PT	VERSION PA	VERSION P