

GRILLO - Laufhilfe MINI

Rechnungsanschrift	
Firma	
Straße und Nr.	
PLZ & Ort	
Telefon	
E-Mail	
Angebot	Bestellung
<input type="checkbox"/>	<input type="checkbox"/>
Lieferadresse	
Firma	
Straße und Nr.	
PLZ & Ort	
Telefon	
E-Mail	
Kommission	
Name	
Nummer	
Besteller	Datum



Anterior
vorwärts

Posterior
rückwärts











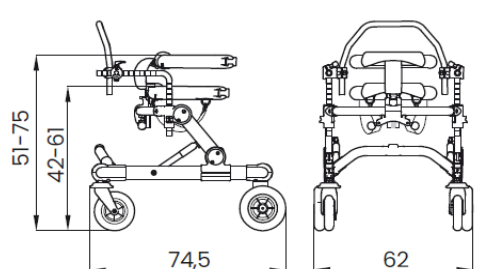
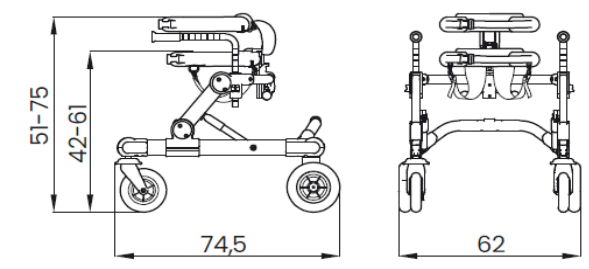

Abb. Enthält Zubehör











Grundausrüstung:

- ✓ Beckenstütze
- ✓ Ergonomische Sitzhose
- ✓ schwenkräder mit Richtungsfeststeller
- ✓ Hinterräder mit Bremse, Rücklaufstopp, Schleifbremse

HMV Nummer 10.46.02.3047

	
<p>Anterior max. Belastung 35kg Körpergröße 75 - 100cm</p>	<p>Posterior max. Belastung 35kg Körpergröße 75 - 100cm</p>

	VERSION PT	VERSION PA	VERSION P
Grillo Mini Variante Posterior (rückwärts)			
	Inklusive: - Thoraxstütze - Beckenstütze - Sitzhose - Handgriffe	Inklusive: - Beckenstütze - Sitzhose - Unterarmauflage	Inklusive: - Beckenstütze - Sitzhose - Handgriffe
Preis Grundmodell	840100105008 <input type="checkbox"/> 3.664 €	840100105010 <input type="checkbox"/> 3.596 €	840100105012 <input type="checkbox"/> 3.344 €
Zubehör Thoraxstütze (925)			
	Inklusive	840100105018 <input type="checkbox"/> 639 €	840100105018 <input type="checkbox"/> 639 €
Zubehör Einstellbare Kopfstütze (865) nur in Verbindung mit Thoraxstütze			
	840100105044 <input type="checkbox"/> 456 €	840100105044 <input type="checkbox"/> 456 €	840100105044 <input type="checkbox"/> 456 €
Zubehör Ergonomischer Sattel (946)			
	840100105046 <input type="checkbox"/> 316 €	840100105046 <input type="checkbox"/> 316 €	840100105046 <input type="checkbox"/> 316 €
Zubehör Schrittführung (890-SC)			
	840100105016 <input type="checkbox"/> 333 €	840100105016 <input type="checkbox"/> 333 €	840100105016 <input type="checkbox"/> 333 €
Zubehör Schiebegriff (923)			
	840100105036 <input type="checkbox"/> 225 €	840100105036 <input type="checkbox"/> 225 €	840100105036 <input type="checkbox"/> 225 €
Zubehör Unterarmauflage (809)			
	840100105030 <input type="checkbox"/> 613 €	Inklusive	840100105030 <input type="checkbox"/> 613 €
Zubehör Armschlaufen für Unterarmauflage (943)			
	840100105040 <input type="checkbox"/> 45 €	840100105040 <input type="checkbox"/> 45 €	840100105040 <input type="checkbox"/> 45 €

	VERSION PT	VERSION PA	VERSION P	VERSION PTM
Grillo Mini Variante Anterior (vorwärts)				
	Inklusive: - Thoraxstütze - Beckenstütze - Sitzhose - Handbügel	Inklusive: - Beckenstütze - Sitzhose - Unterarmauflage	Inklusive: - Beckenstütze - Sitzhose - Handbügel	Inklusive: - Beckenstütze - Sitzhose - Transparenter Tisch mit Handgriffen
Preis Grundmodell	840100105002 <input type="checkbox"/> 3.664 €	840100105004 <input type="checkbox"/> 3.596 €	840100105006 <input type="checkbox"/> 3.344 €	840100105000 <input type="checkbox"/> 3.664 €
Zubehör Thoraxstütze (925)				
	Inklusive	840100105018 <input type="checkbox"/> 639 €	840100105018 <input type="checkbox"/> 639 €	840100105018 <input type="checkbox"/> 639 €
Zubehör Ergonomischer Sattel (946)				
	840100105046 <input type="checkbox"/> 316 €	840100105046 <input type="checkbox"/> 316 €	840100105046 <input type="checkbox"/> 316 €	840100105046 <input type="checkbox"/> 316 €
Zubehör Schrittführung (890-SC)				
	840100105016 <input type="checkbox"/> 333 €	840100105016 <input type="checkbox"/> 333 €	840100105016 <input type="checkbox"/> 333 €	840100105016 <input type="checkbox"/> 333 €
Zubehör Schiebegriff (923)				
	840100105036 <input type="checkbox"/> 225 €	840100105036 <input type="checkbox"/> 225 €	840100105036 <input type="checkbox"/> 225 €	840100105036 <input type="checkbox"/> 225 €
Zubehör Unterarmauflage (809)				
	840100105030 <input type="checkbox"/> 613 €	Inklusive	840100105030 <input type="checkbox"/> 613 €	
Zubehör Armschlaufen für Unterarmauflage (943)				
	840100105040 <input type="checkbox"/> 45 €	840100105040 <input type="checkbox"/> 45 €	840100105040 <input type="checkbox"/> 45 €	